

BS Biomedical Engineering Suggested Four Year Plan

2018 – 2019 Catalog

*Pre-Health Students should consult with their advisors about additional course options.

06/01/2018

A grade of C- or better is required

CS 1336/1136
Programming Fundamentals

CS1336 is required of students with no prior programming experience
Not For Credit in ECS
C- or better needed

Freshman

Description	Course No
Introduction to Bioengineering I	BMEN 1100
Intro to Engineering	ECS 1100
Calculus I	Math 2413 or 2417
General Chemistry for Engineers	Chem 1301
Introduction to Programming	CS 1324
3 hours CORE: choices below	
Freshman Seminar	UNIV 1010

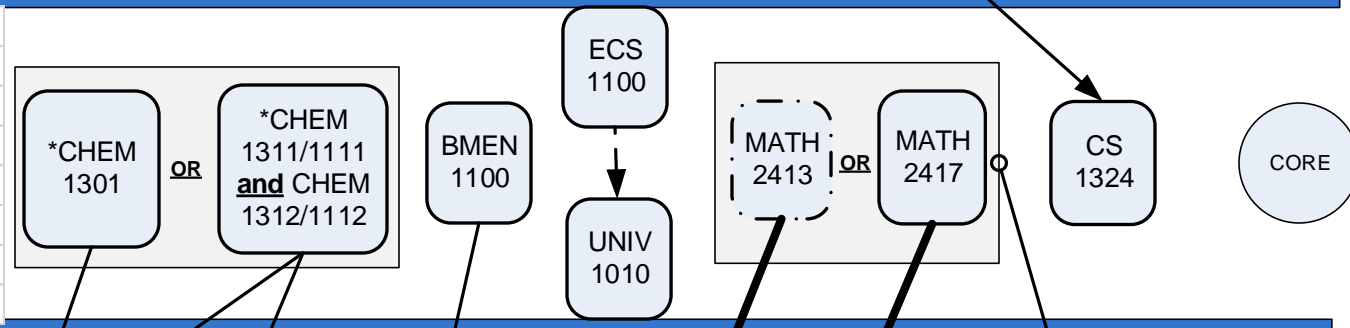

Freshman

Description	Course No
Intro to Bioengineering II	BMEN 1208
Calculus II	Math 2414 or 2419
Intro Organic Chemistry for Engrs	Chem 2324
Mechanics and Heat	Phys 2325
Mechanics and Heat Lab	Phys 2125
3 hours CORE: Choices Below	
Calculus of Several Variables (Summer)	Math2415

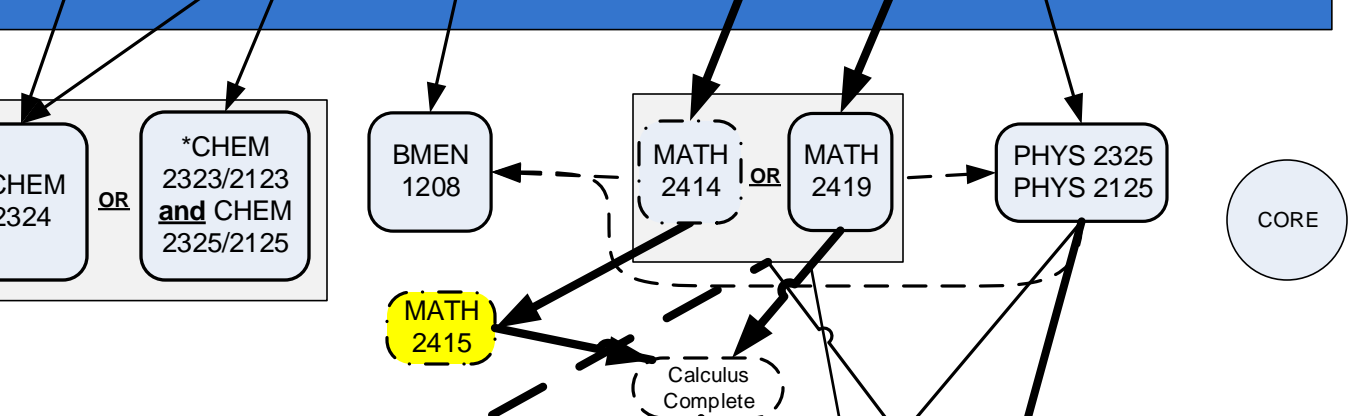

Sophomore

Description	Course No
Statics	BMEN 2320
Linear Algebra for Engineers	ENGR 2300
Electricity and Magnetism	Phys 2326
Electricity and Magnetism Lab	Phys 2126
Intro to Modern Biology I	Biol 2311
Intro to Modern Biology I Wrkshp	Biol 2111
3 hours CORE: choices below	

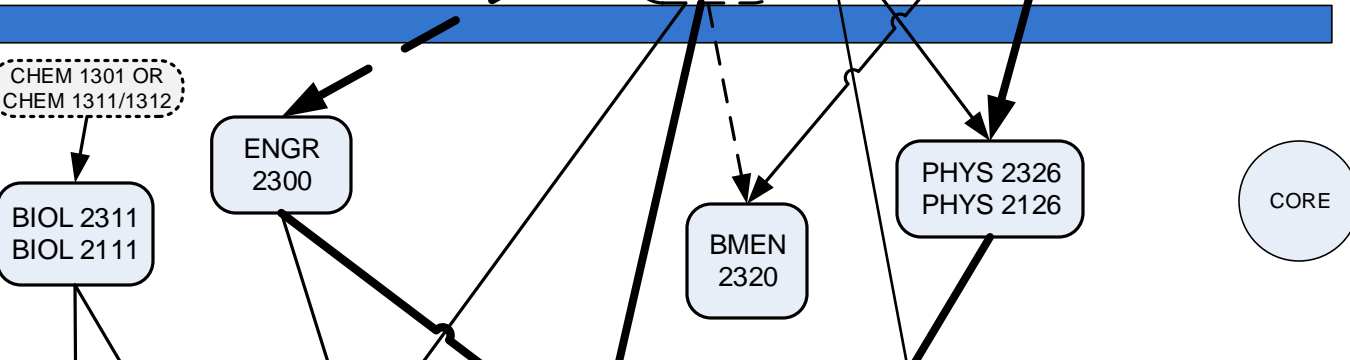

Sophomore

Description	Course No
Advanced Engineering Math	ENGR 3300
Introductory Biology Lab	Biol 2281
Differential Equations	Math 2420
Probability & Statistics	ENGR 3341
6 hours CORE: Choices Below	

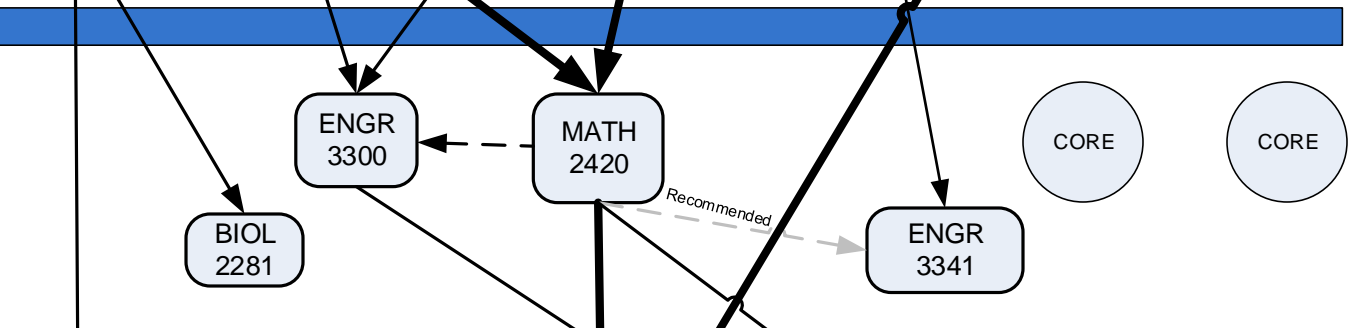

Junior

Description	Course No
Signals and Systems	EE 3302
Signals and Systems Lab	EE 3102
Electrical/Electronic Circuits	BMEN 3320
Electrical/Electronic Circuits Lab	BMEN 3120
Feedback Systems in BMEN	BMEN 4310
Feedback Systems Lab	BMEN 4110
6 hours CORE: Choices Below	

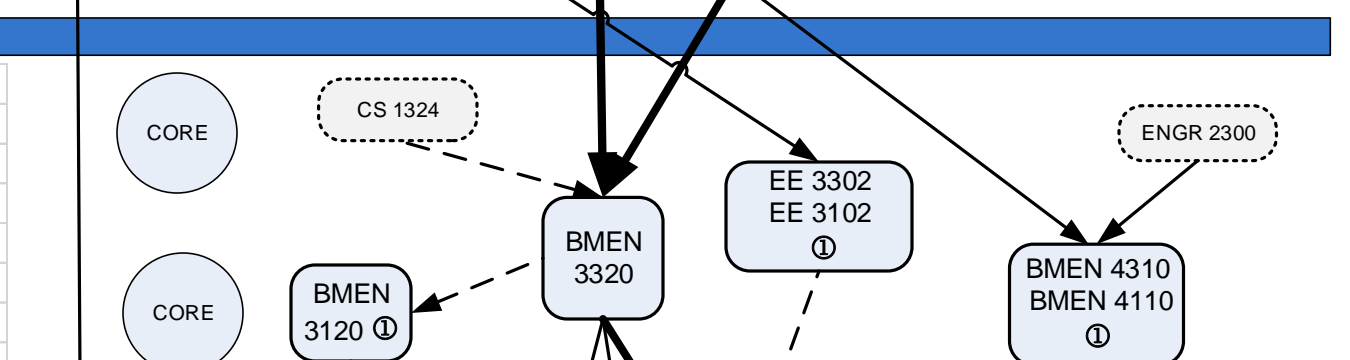

Junior

Description	Course No
BMEN Component & Sys Des	BMEN 3350
BMEN Component & Sys Des Lab	BMEN 3150
Engineering Physiology	BMEN 3330
Engineering Physiology Lab	BMEN 3130
Professional & Technical Comm	ECS 3390
Thermodynamics & Physical Chem OR Thermodynamics	BMEN 3315 OR BMEN 3360

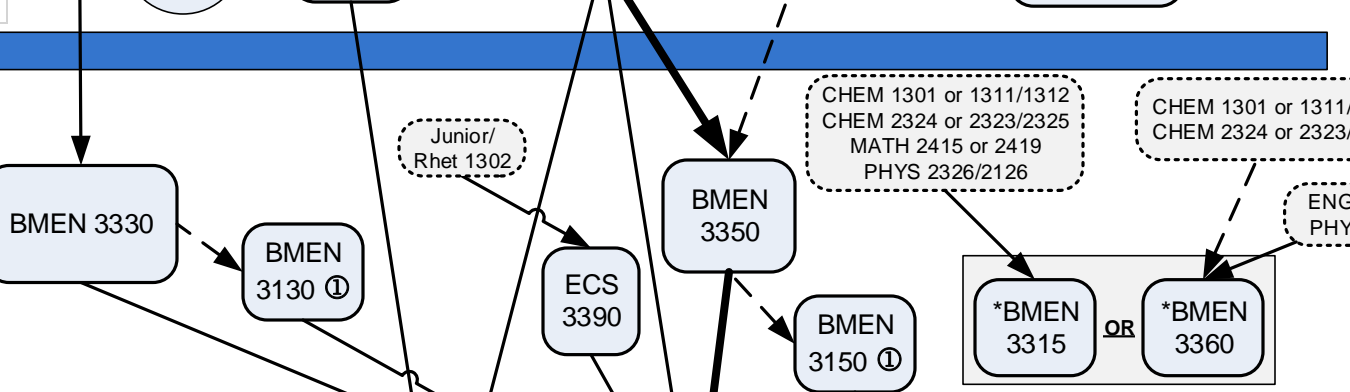

Senior

Description	Course No
Senior Design Project I	BMEN 4388
Social Issues & Ethics in ECS	ECS 3361
Biomaterials & Medical Devices	BMEN 4360
Intermediate Electrical Systems	BMEN 4320

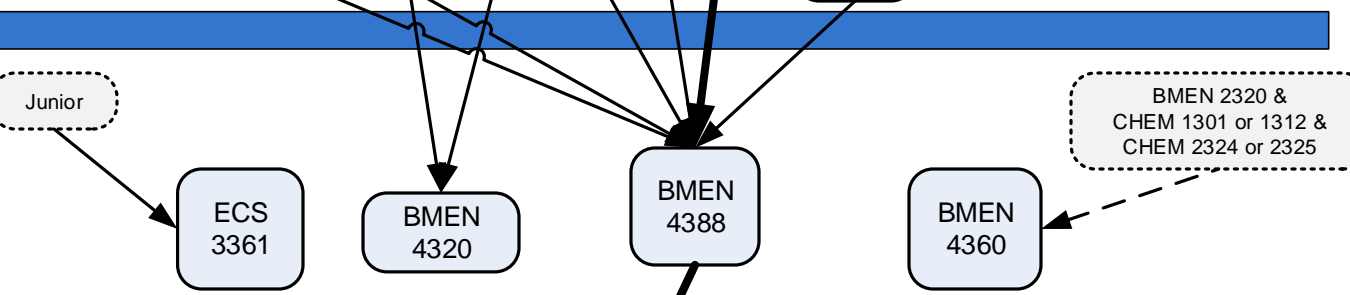

Senior

Description	Course No
Introductory Biomechanics	BMEN 3399
Senior Design Project II	BMEN 4389
3 hours BMEN Prescribed Elective	BMEN XXXX
3 hours BMEN Prescribed Elective	BMEN XXXX
Core Curriculum Assessment	UNIV 2020

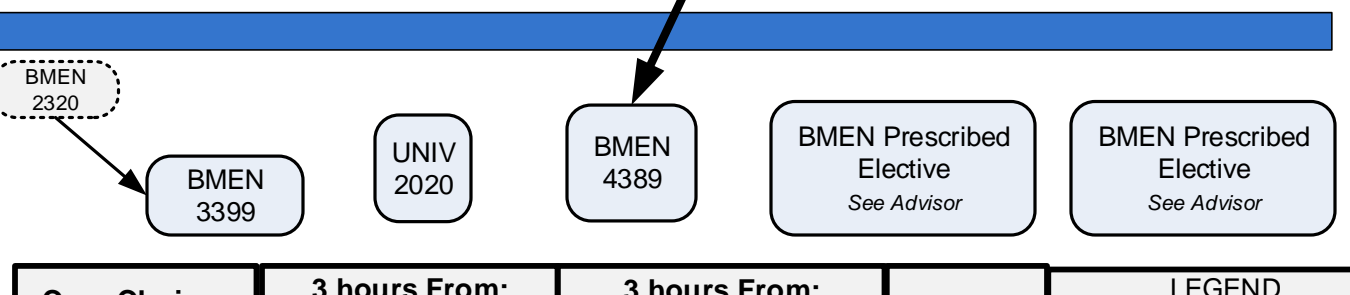

Ⓛ RHET1302 Pre-Req.to some Labs: TAKE BY 3rd SEMESTER

Courses may be taken in any order, as long as prerequisites are met.

Core Choices	3 hours From:	3 hours From:	Rhet 1302	LEGEND
6 hours From: Hist 1301, 1302, 2301, 2330, 2332	Ahst 1303, 1304, 2331 Arts1301 Danc 1310 Film 2332 Musi 1306 Thea 1310	Ams 2300 Ams 2341 Huma 1301 Lit 2331 Phil 1301 Phil 1316, 1317	Govt 2305 Govt 2306	<p>→ Prereq Critical Path</p> <p>→ Pre-requisite</p> <p>- - - Pre- or Co-requisite</p>